

100R5 Crimp Fittings

ORS Swivel Straight FJ3468-

For use with Hose:
1503, FC234, FC300, FC350, FC355

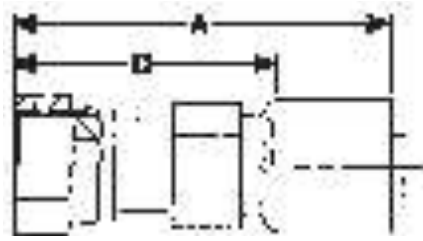

Complete Fitting Part #	Hose Size	A		D	
		mm	in	mm	in
FJ3468-					
0404S	-4	54,6	2.15	34,8	1.37
0405S	-5	56,6	2.23	36,6	1.44
0805S	-5	65,5	2.58	45,0	1.77
0606S	-6	59,9	2.36	40,1	1.58
0608S	-8	62,0	2.44	41,9	1.65
0808S	-8	65,8	2.59	45,5	1.79
0810S	-10	68,1	2.68	45,5	1.79
1010S	-10	72,9	2.87	50,5	1.99
1212S	-12	78,0	3.07	55,6	2.19
1616S	-16	85,9	3.38	61,0	2.40
2020S	-20	78,7	3.10	63,2	2.49
2424S	-24	104,4	4.11	66,5	2.62

ORS Swivel 45° Elbow FJ3254-

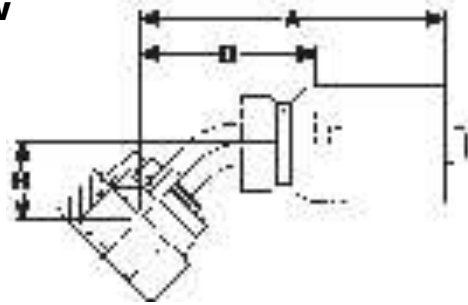

Complete Fitting Part #	Hose Size	A		D		H	
		mm	in	mm	in	mm	in
FJ3254-							
0404S	-4	46,5	1.83	26,7	1.05	11,2	0.44
0606S	-6	50,6	1.99	30,2	1.19	11,2	0.44
0808S	-8	59,4	2.34	39,1	1.54	15,0	0.59
0810S	-10	62,2	2.45	39,9	1.57	15,0	0.59
1010S	-10	67,3	2.65	45,1	1.77	17,6	0.69
1212S	-12	73,2	2.88	50,8	1.99	21,1	0.83
1616S	-16	82,7	3.25	57,7	2.27	24,1	0.95

ORS Swivel 90° Elbow (Short) FJ3255-

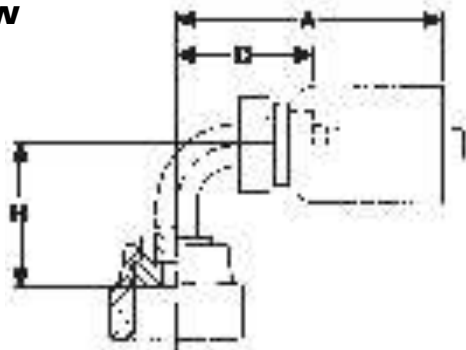

Complete Fitting Part #	Hose Size	A		D		H	
		mm	in	mm	in	mm	in
FJ3255-							
0404S	-4	40,9	1.61	21,1	.83	21,4	.84
0605S	-5	46,7	1.84	26,7	1.05	23,1	.91
0406S	-6	43,6	1.72	23,6	.93	21,4	.84
0606S	-6	46,7	1.84	26,7	1.05	23,1	.91
0608S	-8	47,2	1.86	27,1	1.07	23,9	.94
0808S	-8	52,5	2.07	32,3	1.27	29,2	1.15
1010S	-10	58,4	2.30	36,1	1.42	33,3	1.31
1212S	-12	70,6	2.78	48,3	1.90	48,3	1.90
1616S	-16	81,0	3.19	55,9	2.20	56,4	2.22
2020s	-20	92,7	3.65	62,7	2.47	63,4	2.50

SAE 37° (JIC) Swivel FJ3114-

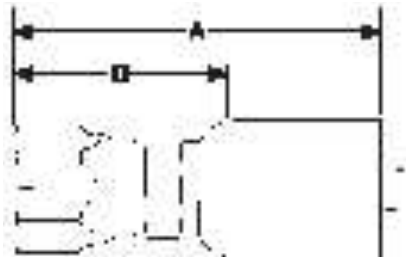

Complete Fitting Part #	Hose Size	A		D	
		mm	in	mm	in
FJ3114-					
0404S	-4	47,8	1.88	27,9	1.10
0604S	-4	51,6	2.03	31,8	1.25
0405S	-5	48,0	1.89	27,9	1.10
0505S	-5	49,3	1.94	29,2	1.15
0606S	-6	51,8	2.04	31,8	1.25
0608S	-8	53,9	2.12	33,5	1.32
0808S	-8	54,6	2.15	34,2	1.35
0810S	-10	58,2	2.29	35,8	1.41
1010S	-10	61,2	2.41	38,9	1.53
1012S	-12	62,0	2.44	39,0	1.54
1212S	-12	61,7	2.43	39,4	1.55
1216S	-16	70,9	2.79	45,7	1.80
1616S	-16	70,4	2.77	43,9	1.73
2020S	-20	75,4	2.97	45,5	1.79
2024S	-24	83,2	3.28	45,5	1.79
2424S	-24	87,1	3.43	49,3	1.94
3232S	-32	108,0	4.25	59,2	2.33

¹FJ3114-3232S is factory crimp only.

Straight SAE 45° Swivel FJ3094-

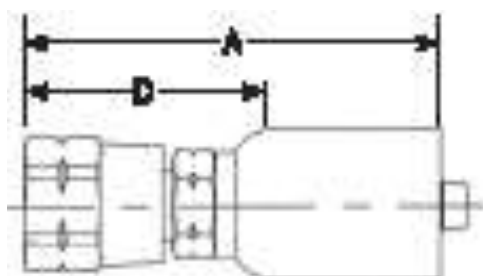

Complete Fitting Part #	Hose Size	A		D	
		mm	in	mm	in
FJ3094-					
0404S	-4	47,8	1.88	26,9	1.10
0405S	-5	49,3	1.94	27,9	1.15
0505S	-5	53,1	2.09	28,7	1.13
0606S	-6	52,7	2.07	32,5	1.28
0806S	-6	61,2	2.41	33,5	1.32
0808S	-8	54,5	2.15	34,3	1.35
0810S	-10	64,5	2.54	36,8	1.45
1010S	-10	61,2	2.41	38,8	1.53
1212S	-12	61,8	2.43	39,4	1.55

100R5 Crimp Fittings

For use with Hose:
1503, FC234, FC300, FC350, FC355

45° Elbow

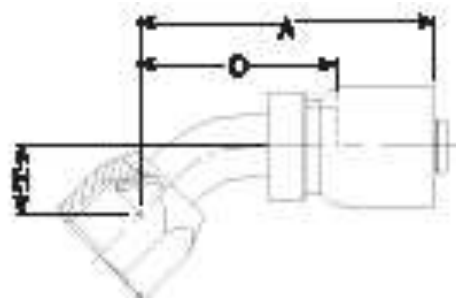

**FJ3243 -
Universal Swivel**

**FJ3246 -
SAE 45° Swivel**

**FJ3249 -
SAE 37° (JIC) Swivel**

Complete Fitting Part #	Hose Size	A		D		H	
		mm	in	mm	in	mm	in
FJ3243-							
0404S	-4	43,7	1.72	23,9	.94	8,3	.33
0505S	-5	45,5	1.79	25,1	.99	9,1	.36
0808S	-8	58,4	2.30	40,2	1.58	14,0	.55
0810S	-10	61,5	2.42	39,1	1.54	14,0	.55
1010S	-10	63,5	2.50	41,1	1.62	16,0	.63
FJ3246-							
0606S	-6	49,3	1.94	29,2	1.15	9,9	.39
1212S	-12	71,7	2.82	49,3	1.94	19,7	.77
FJ3249-							
0606S	-6	49,3	1.94	29,2	1.15	9,9	.39
0608S	-8	49,8	1.96	29,2	1.15	9,9	.39
1212S	-12	71,7	2.82	49,3	1.94	19,7	.77
1616S	-16	85,7	3.38	60,7	2.39	27,1	1.07
2020S	-20	100,7	3.96	65,9	2.59	31,0	1.22

90° Elbow (Short)

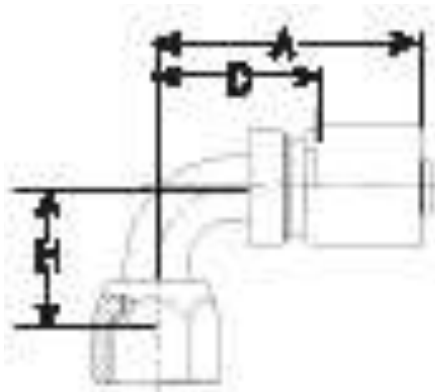

**FJ3244 -
Universal Swivel**

**FJ3247 -
SAE 45° Swivel**

**FJ3250 -
SAE 37° (JIC) Swivel**

Complete Fitting Part #	Hose Size	A		D		H	
		mm	in	mm	in	mm	in
FJ3244-							
0404S	-4	40,9	1.61	21,1	.83	17,3	.68
0405S	-5	41,2	1.62	21,1	.83	17,3	.68
0505S	-5	42,7	1.68	22,5	.89	19,5	.77
0808S	-8	52,6	2.07	32,3	1.27	27,7	1.09
0810S	-10	55,1	2.17	32,9	1.29	27,7	1.09
1010S	-10	63,7	2.51	41,4	1.63	31,2	1.23
1012S	-12	66,1	2.60	43,4	1.71	31,2	1.23
FJ3247-							
0606S	-6	46,6	1.84	26,7	1.05	21,6	.85
1212S	12	70,6	2.78	48,3	1.90	46,2	1.82
FJ3250-							
0604S	-4	46,5	1.83	26,7	1.05	21,6	.85
0606S	-6	46,7	1.84	26,7	1.05	21,6	.85
0608S	-8	47,0	1.85	26,7	1.05	21,6	.85
1212S	-12	70,6	2.78	48,3	1.90	46,2	1.82
1216S	-16	74,7	2.94	49,5	1.95	46,2	1.82
1616S	-16	80,9	3.19	55,9	2.20	60,8	2.39
2020S	-20	108,5	4.27	73,7	2.90	82,6	3.25
2424S	-24	108,5	4.27	70,8	2.79	77,5	3.05

Male Pipe

FJ3152-

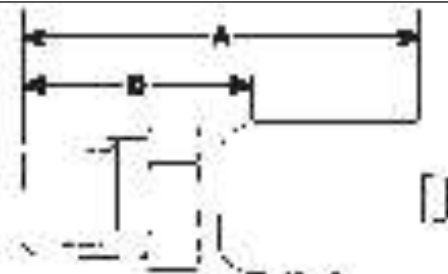

Complete Fitting Part #	Hose Size	A		D	
		mm	in	mm	in
FJ3152-					
0204S	-4	45,3	1.78	25,5	1.00
0404S	-4	46,9	1.85	27,0	1.06
0405S	-5	47,8	1.88	23,6	.93
0406S	-6	47,1	1.85	27,0	1.06
0606S	-6	47,1	1.85	27,0	1.06
0608S	-8	51,8	2.04	24,9	.98
0808S	-8	54,6	2.15	34,4	1.35
0810S	-10	56,9	2.24	34,5	1.36
1210S	-10	62,7	2.47	35,1	1.38
1212S	-12	56,9	2.24	34,5	1.36
1216S	-16	68,3	2.69	35,6	1.40
1616S	-16	66,3	2.61	41,3	1.63
2020S	-20	75,7	2.98	45,6	1.79
2424S	-24	85,9	3.38	48,2	1.90
3232S	-32	104,3	4.11	55,6	2.19

*Pictures may not represent actual configuration.
Call Eaton Technical Assistance for details.

#Consult Eaton for most current crimp information.

SPECIALTY &
TRUCK HOSE

LOW & MEDIUM
PRESSURE HOSE

HIGH PRESSURE HOSE

HOSE FITTINGS

ADAPTERS &
TUBE FITTINGS

ACCESSORIES &
ASSEMBLY INSTRUCTIONS

HOSE ASSEMBLY
EQUIPMENT

APPENDICIES

Reusable Fittings

100R5 Style

For use with Hose:

302A, 303, 1503, 2580, 2651,
FC234, FC300, FC321, FC350,
FC355

Male Pipe

412-
44-412-

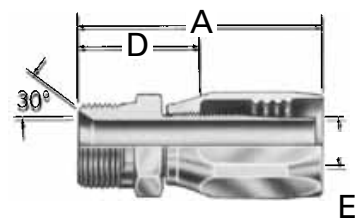

Dash Size	Thread	Hose Size	A		D		EØ	
			mm	in	mm	in	mm	in
412-								
t2-4S*	1/8-27	-04	42,7	1.68	23,4	.92	4,3	.17
t4-4S*	1/4-18	-04	47,2	1.86	28,2	1.11	4,3	.17
t2-5S*	1/8-27	-05	45,2	1.78	25,4	1.00	5,8	.23
t4-5S*	1/4-18	-05	49,8	1.96	30,0	1.18	5,8	.23
t4-6S*	1/4-18	-06	54,1	2.13	31,2	1.23	7,6	.30
t6-6S*	3/8-18	-06	54,1	2.13	31,2	1.23	6,1	.24
t6-8S*	3/8-18	-08	63,0	2.48	33,8	1.33	9,9	.39
8-8S*	1/2-14	-08	69,3	2.73	40,1	1.58	9,1	.36
t8-10S*	1/2-14	-10	73,2	2.88	40,4	1.59	12,2	.48
12-10S*	3/4-14	-10	74,7	2.94	41,9	1.65	12,2	.48
t12-12S*	3/4-14	-12	82,3	3.24	42,4	1.67	15,5	.61
t12-16S	3/4-14	-16	71,1	2.80	38,9	1.53	20,8	.82
t16-16S	1-11 1/2	-16	75,9	2.99	43,7	1.72	20,8	.82
16-20S	1-11 1/2	-20	81,3	3.20	46,7	1.72	24,1	.95
t20-20S	1 1/4-11 1/2	-20	82,0	3.23	47,5	1.87	26,7	1.05
20-24S	1 1/4-11 1/2	-24	90,9	3.58	53,8	2.12	32,5	1.28
t24-24S	1 1/2-11 1/2	-24	88,4	3.48	51,6	2.03	32,5	1.28
t32-32S	2-11 1/2	-32	102,9	4.05	55,9	2.20	44,5	1.75
44-412-								
40-40	2 1/2-8	-40	127,8	5.03	79,5	3.13	53,8	2.12
48-48	3-8	-48	129,3	5.09	81,0	3.19	68,3	2.69

Male Pipe

4412-

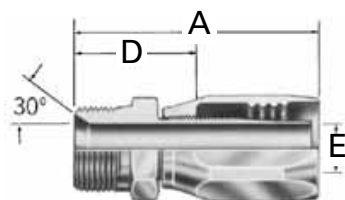

4412-	Thread	Hose Size	mm		in	
			mm	in	mm	in
2-4S	1/8-27	-04	42,7	1.68	23,6	.93
4-4S	1/4-18	-04	47,5	1.87	28,4	1.12
4-5S	1/4-18	-05	49,8	1.96	30,0	1.18
4-6St	1/4-18	-06	54,1	2.13	31,2	1.23
6-6S	3/8-18	-06	54,1	2.13	31,2	1.23
4-8S	1/4-18	-08	63,0	2.48	33,8	1.33
6-8S	3/8-18	-08	63,0	2.48	33,8	1.33
8-8S	1/2-14	-08	69,3	2.73	40,1	1.58
8-10S	1/2-14	-10	73,2	2.88	40,4	1.59
12-10S	3/4-14	-10	74,7	2.94	41,9	1.65
8-12S	1/2-14	-12	82,3	3.24	42,7	1.68
12-12S	3/4-14	-12	82,3	3.24	42,4	1.67

SAE 37° (JIC) swivel

411-
44-411-

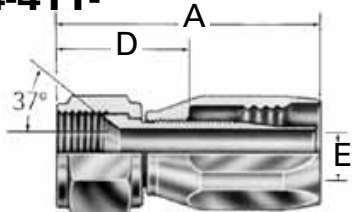

411-	Thread	Hose Size	mm		in	
			mm	in	mm	in
t4S*	7/16-20	-4	44,5	1.75	25,4	1.00
t5S*	1/2-20	-5	48,3	1.90	28,4	1.12
t6S*	9/16-18	-6	52,1	2.05	29,2	1.15
t8S*	3/4-16	-8	64,0	2.52	35,1	1.38
10S*	7/8-14	-10	71,1	2.80	38,4	1.51
t12S*	1 1/16-12	-12	80,0	3.15	40,1	1.58
t16S*	1 5/16-12	-16	71,6	2.82	39,4	1.55
t20S*†††	1 5/8-12	-20	76,2	3.00	41,7	1.64
t24S*†††	1 7/8-12	-24	83,3	3.28	46,5	1.83
t32S*†††	2 1/2-12	-32	98,6	3.88	51,6	2.03
44-411-						
40*	3-12	-40	105,7	4.16	57,2	2.25
48*	3 1/2-12	-48	108,7	4.28	60,5	2.38

*Requires tools for assembly.

†Also supplied in brass. To order, substitute "B" for "S" in part number.

†††Available in stainless steel. To order, drop the "S" suffix and add "259-" prefix.

NOTE: For correct socket part number, see page 65

Reusable Fittings

100R5 Style

For use with Hose:

302A, 303, 1503, 2580, 2651,
FC234, FC300, FC321, FC350,
FC355

SAE 37° (JIC) swivel

4411-

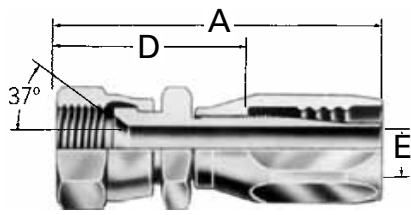

Dash Size	Thread	Hose Size	A		D		EØ	
			mm	in	mm	in	mm	in
4411-								
4S†††	7/16-20	-04	50,0	1.97	31,2	1.23	3,3	.13
4-5S	7/16-20	-05	52,8	2.08	33,0	1.30	4,3	.17
5S†††	1/2-20	-05	53,8	2.12	34,3	1.35	4,6	.18
6S†††	9/16-18	-06	59,2	2.33	36,3	1.43	6,1	.24
8-6S	3/4-16	-06	61,5	2.42	38,6	1.52	6,1	.24
6-8S	9/16-18	-08	68,1	2.68	38,9	1.53	7,6	.30
8S†††	3/4-16	-08	70,6	2.78	41,1	1.62	9,1	.36
10-8S	7/8-14	-08	74,9	2.95	45,7	1.80	9,1	.36
8-10S	3/4-16	-10	74,2	2.92	41,7	1.64	9,9	.39
10S†††	7/8-14	-10	78,7	3.10	46,0	1.81	11,7	.46
12-10S	1 1/16-12	-10	81,0	3.19	48,5	1.91	11,7	.46
10-12S	7/8-14	-12	86,4	3.40	46,5	1.83	14,0	.55
12S†††	1 1/16-12	-12	88,6	3.49	48,8	1.92	14,0	.55
14-12S	1 3/16-12	-12	90,6	3.56	50,5	1.99	14,0	.55
16S†††	1 5/16-12	-16	81,0	3.19	49,0	1.93	20,8	.82
20S	1 5/8-12	-20	87,1	3.43	52,6	2.07	26,7	1.05
20-24S	1 5/8-12	-24	92,7	3.65	55,6	2.19	26,9	1.06
24S	1 7/8-12	-24	93,5	3.68	56,4	2.22	32,5	1.28
32S	2 1/2-12	-32	111,5	4.39	64,8	2.55	44,5	1.75

SAE 45° swivel

401-

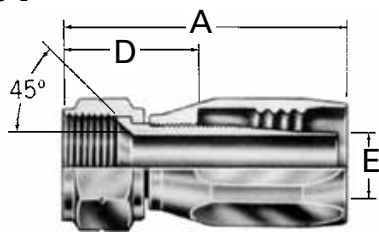

Dash Size	Thread	Hose Size	A		D		EØ	
			mm	in	mm	in	mm	in
401-								
4S*†	7/16-20	-04	44,5	1.75	25,4	1.00	4,3	.17
5S*†	1/2-20	-05	48,3	1.90	28,4	1.12	5,8	.23
6S*†	5/8-18	-06	52,1	2.05	29,2	1.15	7,6	.30
8S*†	3/4-16	-08	64,0	2.52	35,1	1.38	9,9	.39
10S*†	7/8-14	-10	71,1	2.80	38,4	1.51	12,2	.48
12S*†	1 1/16-14	-12	76,7	3.02	36,8	1.45	15,5	.61

SAE 45° swivel

4401-

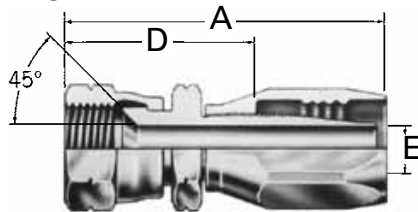

Dash Size	Thread	Hose Size	A		D		EØ	
			mm	in	mm	in	mm	in
4401-								
4S	7/16-20	-04	50,0	1.97	31,0	1.22	3,3	.13
5S	1/2-20	-05	53,8	2.12	34,0	1.34	4,3	.17
6S	5/8-18	-06	59,9	2.36	37,1	1.46	6,1	.24
8S	3/4-16	-08	70,6	2.78	41,1	1.62	9,1	.36
10S	7/8-14	-10	78,7	3.10	46,0	1.81	11,7	.46
12S	1 1/16-14	-12	88,6	3.49	48,8	1.92	14,0	.55

SAE PTT swivel

406-

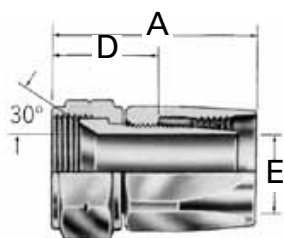

Dash Size	Thread	Hose Size	A		D		EØ	
			mm	in	mm	in	mm	in
406-								
16B††††*	1 5/16-14	-16	66,0	2.60	33,8	1.33	20,8	.82
20B††††*	1 5/8-14	-20	72,6	2.86	38,1	1.50	26,7	1.05
24B*	1 7/8-14	-24	79,5	3.13	42,4	1.67	32,5	1.28

*Requires tools for assembly.

† Also supplied in brass. To order, substitute "B" for "S" in part number.

†† Available in stainless steel. To order, drop the "S" suffix and add "259-" prefix.

††† Also supplied in steel. To order, drop "B" suffix and substitute "S" in part number.

NOTE: For correct socket part number, see page 65.

SPECIALTY &
TRUCK HOSE

LOW & MEDIUM
PRESSURE HOSE

HIGH PRESSURE HOSE

HOSE FITTINGS

ADAPTERS &
TUBE FITTINGS

ACCESSORIES &
ASSEMBLY INSTRUCTIONS

HOSE ASSEMBLY
EQUIPMENT

APPENDICES

Reusable Fittings

100R5 Style

SAE Male O-Ring Boss**

190463-

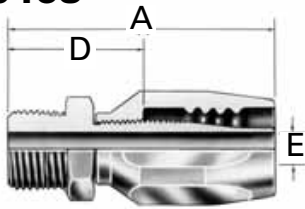

For use with Hose:

302A, 303, 1503, 2580, 2651,
FC234, FC300, FC321, FC350,
FC355

Dash Size	Thread	Hose Size	A		D		EØ	
			mm	in	mm	in	mm	in
190463-								
6S	9/16-18	-06	49,5	1.95	26,7	1.05	6,1	.24
8S	3/4-16	-08	59,7	2.35	30,5	1.20	9,1	.36
10S	7/8-14	-10	66,8	2.63	34,0	1.34	9,1	.36

SAE 37° (JIC) Male Flare

4414-

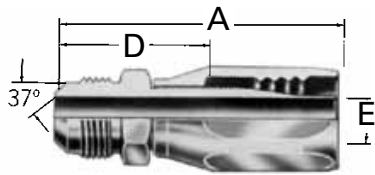

Dash Size	Thread	Hose Size	A		D		EØ	
			mm	in	mm	in	mm	in
4414-								
4S	7/16-20	-04	47,0	1.85	27,9	1.10	3,3	.13
5S	1/2-20	-05	49,5	1.95	29,7	1.17	4,3	.17
6S	9/16-18	-06	53,8	2.12	31,0	1.22	6,1	.24
8S	3/4-16	-08	65,3	2.57	36,1	1.42	9,1	.36
10S	7/8-14	-10	73,2	2.88	40,6	1.60	11,7	.46
12-10S	1 1/16-12	-10	77,5	3.05	44,7	1.76	11,7	.46
12S	1 1/16-12	-12	85,1	3.35	45,2	1.78	14,0	.55
16-12S	1 5/16-12	-12	86,4	3.40	46,5	1.83	14,0	.55
16S	1 5/16-12	-16	75,2	2.96	42,9	1.69	20,8	.82
20S	1 5/8-12	-20	81,8	3.22	47,2	1.86	26,7	1.05
24S	1 7/8-12	-24	87,4	3.44	50,5	1.99	32,5	1.28
32S	2 1/2-12	-32	107,2	4.22	60,5	2.38	44,5	1.75

SAE 45° Male Flare

4402-

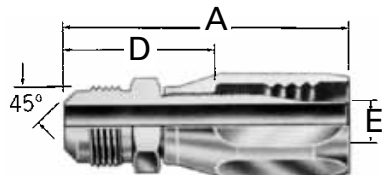

Dash Size	Thread	Hose Size	A		D		EØ	
			mm	in	mm	in	mm	in
4402-								
4S	7/16-20	-04	45,7	1.80	26,9	1.06	3,3	.13
4-5S	7/16-20	-05	48,3	1.90	28,4	1.12	4,3	.17
5S	1/2-20	-05	50,0	1.97	30,0	1.18	4,3	.17
6S	5/8-18	-06	55,6	2.19	32,5	1.28	6,1	.24
8S	3/4-16	-08	67,6	2.66	38,6	1.52	9,1	.36
10S	7/8-14	-10	76,2	3.00	43,7	1.72	11,7	.46
12-10S	1 1/16-14	-10	81,3	3.20	48,3	1.90	11,7	.46
12S	1 1/16-14	-12	88,9	3.50	48,8	1.92	14,2	.56

Lifesaver†

190000-

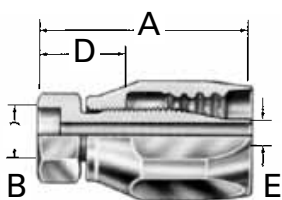

Dash Size	Tube	Hose Size	A		B†		D		EØ	
			mm	in	mm	in	mm	in	mm	in
190000-										
4S	1/4	-04	34,5	1.36	6,4	.25	15,7	.62	3,3	.13
5S	5/16	-05	38,9	1.53	7,9	.31	19,1	.75	4,6	.18
5-6S	5/16	-06	41,4	1.63	7,9	.31	18,5	.73	6,1	.24
6S	3/8	-06	41,4	1.63	9,7	.38	18,5	.73	6,1	.24
6-8S	3/8	-08	51,8	2.04	9,7	.38	22,6	.89	7,1	.28
8S	1/2	-08	51,8	2.04	12,7	.50	22,6	.89	9,1	.36
10S	5/8	-10	55,6	2.19	15,7	.62	22,9	.90	11,7	.46
8-12S	1/2	-12	63,2	2.49	12,7	.50	23,4	.92	9,9	.39
12S	3/4	-12	63,2	2.49	19,1	.75	23,4	.92	14,0	.55
16S	1	-16	52,1	2.05	25,4	1.00	19,8	.78	20,8	.82
16-20S	1	-20	57,4	2.26	25,4	1.00	22,9	.90	20,8	.82
18-20S	1 1/8	-20	57,4	2.26	28,4	1.12	22,9	.90	23,9	.94
20S	1 1/4	-20	57,4	2.26	31,8	1.25	22,9	.90	26,7	1.05
24-20S	1/2	-20	59,2	2.33	38,1	1.50	24,4	.96	26,7	1.05
16-24S	1	-24	61,5	2.42	25,4	1.00	24,6	.97	20,8	.82
20-24S	1 1/4	-24	59,9	2.36	31,8	1.25	22,9	.90	26,7	1.05
24-24S	1/2	-24	61,5	2.42	38,1	1.50	24,6	.97	32,5	1.28
20-32S	1 1/4	-32	73,4	2.89	31,8	1.25	26,7	1.05	26,9	1.06
24-32S	1/2	-32	71,9	2.83	38,1	1.50	24,9	.98	34,8	1.37
32-32S	2	-32	73,4	2.89	50,8	2.00	26,7	1.05	44,5	1.75
40S	2 1/2	-40	82,8	3.26	63,5	2.50	34,5	1.36	56,1	2.21

**See pages 194, 195 for o-rings.

†"B" dimension is counterbore diameter for mating tubing.

NOTE: For correct socket part number, see page 65.

Reusable Fittings

100R5 Style

For use with Hose:

302A, 303, 1503, 2580, 2651,
FC234, FC300, FC321, FC350,
FC355

45° Elbow

**190297 -
Universal Swivel**

**190299 -
SAE 45° Swivel**

**190265 -
SAE 37° (JIC) Swivel**

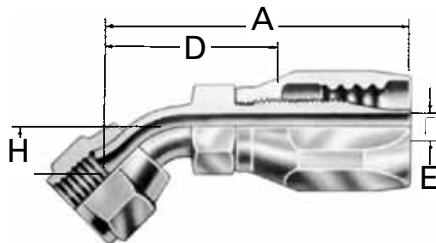

Dash Size	Thread	Hose Size	A		D		EØ		H	
			mm	in	mm	in	mm	in	mm	in
190297-										
4S	7/16-20	-04	47,0	1.85	27,9	1.10	3,3	.13	8,4	.33
4-5S	7/16-20	-05	51,1	2.01	31,2	1.23	3,8	.15	8,4	.33
5S	1/2-20	-05	52,6	2.07	32,8	1.29	4,6	.18	9,1	.36
8-6S	3/4-16	-06	67,1	2.64	44,2	1.74	6,1	.24	14,0	.55
8S	3/4-16	-08	75,9	2.99	46,7	1.72	9,1	.36	14,0	.55
8-10S	3/4-16	-10	79,8	3.14	47,0	1.85	9,9	.39	14,0	.55
10S	7/8-14	-10	82,3	3.24	49,5	1.95	11,7	.46	16,3	.64
10-12S	7/8-14	-12	89,9	3.54	50,0	1.97	12,2	.48	16,3	.64
190299-										
6S	5/8-18	-06	56,6	2.23	33,8	1.33	6,1	.24	9,9	.39
12S	1 1/16-14	-12	96,0	3.78	56,1	2.21	14,0	.55	19,8	.78
190265-										
6-5S	9/16-18	-05	54,1	2.13	34,3	1.35	4,3	.17	9,9	.39
6S	9/16-18	-06	56,6	2.23	33,8	1.33	6,1	.24	9,9	.39
12S	1 1/16-12	-12	96,0	3.78	56,1	2.21	14,0	.55	19,8	.78
16-12S	1 5/16-12	-12	101,6	4.00	61,7	2.43	14,0	.55	25,1	.99
16S	1 5/16-12	-16	95,0	3.74	62,7	2.47	20,8	.82	27,2	1.07
20S	1 1/8-12	-20	106,9	4.21	72,4	2.85	26,7	1.05	31,0	1.22

90° Elbow (Short)

**190296-
Universal Swivel,**

**190302-
SAE 45° Swivel,**

**190261-
SAE 37° (JIC) Swivel**

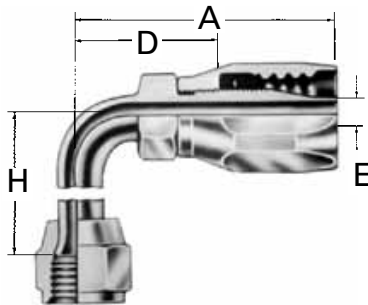

NOTE: For correct socket part number, see page 65.

Dash Size	Thread	Hose Size	A		D		EØ		H	
			mm	in	mm	in	mm	in	mm	in
190296-										
4S	7/16-20	-04	44,2	1.74	25,1	.99	3,3	.13	17,3	.68
5S	1/2-20	-05	49,8	1.96	30,0	1.18	4,3	.17	19,6	.77
8S	3/4-16	-08	70,1	2.76	40,9	1.61	9,1	.36	27,7	1.09
10S	7/8-14	-10	74,7	2.94	41,9	1.65	11,7	.46	31,2	1.23
8-12S	3/4-16	-12	81,5	3.21	41,7	1.64	9,9	.39	27,7	1.09
190302-										
6S	5/8-18	-06	54,1	2.13	31,2	1.23	6,1	.24	21,6	.85
12S	1 1/16-14	-12	95,0	3.74	55,1	2.17	14,0	.55	46,2	1.82
190261-										
6S	9/16-18	-06	54,1	2.13	31,2	1.23	6,1	.24	21,6	.85
12S	1 1/16-12	-12	95,0	3.74	55,1	2.17	14,0	.55	46,2	1.82
16-12S	1 5/16-12	-12	95,0	3.74	55,1	2.17	14,0	.55	54,4	2.14
16S	1 5/16-12	-16	90,2	3.55	57,9	2.28	20,8	.82	58,4	2.30
20-16S	1 5/8-12	-16	90,2	3.55	57,9	2.28	19,3	.76	63,5	2.50
20S	1 5/8-12	-20	102,1	4.02	67,3	2.65	26,7	1.05	69,9	2.75
20-24S	1 5/8-12	-24	104,4	4.11	67,6	2.66	26,7	1.05	69,9	2.75

90° Elbow (Long)

**190295-
Universal Swivel,**

**190301-
SAE 45° Swivel,**

**190260-
SAE 37° (JIC) Swivel**

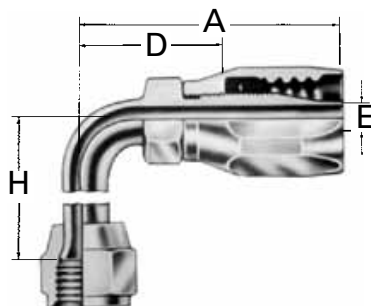

Dash Size	Thread	Hose Size	A		D		EØ		H	
			mm	in	mm	in	mm	in	mm	in
190295-										
4S	7/16-20	-04	44,2	1.74	25,1	.99	3,3	.13	45,7	1.80
5S	1/2-20	-05	49,8	1.96	30,0	1.18	4,6	.18	45,0	1.77
8S	3/4-16	-08	73,2	2.88	43,9	1.73	9,1	.36	61,7	2.43
10S	7/8-14	-10	81,0	3.19	48,3	1.90	11,7	.46	65,3	2.57
10-12S	7/8-14	-12	88,6	3.49	48,8	1.92	12,2	.48	65,3	2.57
190301-										
6S	5/8-18	-06	54,1	2.13	31,2	1.23	6,1	.24	55,4	2.18
12S	1 1/16-14	-12	95,0	3.74	55,1	2.17	14,0	.55	94,7	3.73
190260-										
6S	9/16-18	-06	54,1	2.13	31,2	1.23	6,1	.24	55,4	2.18
12S	1 1/16-12	-12	95,0	3.74	55,1	2.17	14,0	.55	94,7	3.73
16S	1 5/16-12	-16	90,2	3.55	57,9	2.28	20,8	.82	116,3	4.58
20S	1 5/8-12	-20	102,1	4.02	67,3	2.65	26,7	1.05	140,5	5.53

Reusable Fittings

100R5 Style

For use with Hose:

302A, 303, 1503, 2580, 2651,
FC234, FC300, FC321, FC350,
FC355

Code 61 SAE J518 Straight Split Flange

4775-

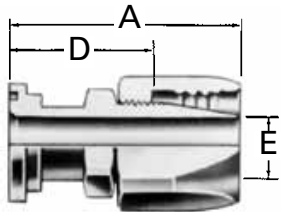

Dash Size	Flange Head Dia.		Hose Size	A		D		EØ	
	mm	in		mm	in	mm	in	mm	in
4775-									
8S	30,2	1.19	-08	70,4	2.77	41,1	1.62	9,1	.36
8-10S	30,2	1.19	-10	84,3	3.32	51,6	2.03	11,7	.46
16-10S	44,5	1.75	-10	75,4	2.97	42,7	1.68	11,7	.46
12S	38,1	1.50	-12	80,3	3.16	40,4	1.59	14,0	.55
16-12S	44,5	1.75	-12	90,2	3.55	50,3	1.98	14,0	.55
20-12S	50,8	2.00	-12	90,2	3.55	50,3	1.98	14,0	.55
16S	44,5	1.75	-16	70,4	2.77	38,1	1.50	20,8	.82
20-16S	50,8	2.00	-16	85,3	3.36	53,1	2.09	20,8	.82
24-16S	60,5	2.38	-16	86,9	3.42	54,4	2.14	20,8	.82
16-20S	44,5	1.75	-20	75,9	2.99	41,1	1.62	20,8	.82
20S	50,8	2.00	-20	90,9	3.58	56,1	2.21	26,7	1.05
32-20S	71,4	2.81	-20	92,5	3.64	57,9	2.28	26,7	1.05
16-24S	44,5	1.75	-24	94,7	3.73	57,9	2.28	20,8	.82
20-24S	50,8	2.00	-24	93,2	3.67	56,4	2.22	26,7	1.05
24S	60,5	2.38	-24	102,1	4.02	65,0	2.56	32,5	1.28
32-24S	71,4	2.81	-24	102,1	4.02	65,0	2.56	32,5	1.28
20-32S	50,8	2.00	-32	133,6	5.26	86,9	3.42	26,9	1.06
24-32S	60,5	2.38	-32	112,3	4.42	65,5	2.58	34,8	1.37
32S	71,4	2.81	-32	125,0	4.92	78,2	3.08	44,5	1.75
40-32S	84,1	3.31	-32	126,5	4.98	79,8	3.14	44,5	1.75
40*	84,1	3.31	-40	136,1	5.36	87,6	3.45	56,1	2.21

Code 61 SAE J518 22½° Split Flange

4776-

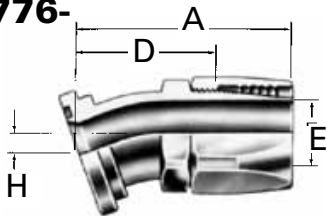

Dash Size	Flange Head Dia.		Hose Size	A		D		EØ		H	
	mm	in		mm	in	mm	in	mm	in	mm	in
4776-											
16S	44,5	1.75	-16	90,2	3.55	57,9	2.28	20,8	.82	12,7	.50
32-16S	71,4	2.81	-16	89,4	3.52	57,4	2.26	20,8	.82	12,4	.49
20S	50,8	2.00	-20	97,0	3.82	62,2	2.45	26,7	1.05	12,7	.50
32-20S	71,4	2.81	-20S	98,6	3.88	63,8	2.51	26,7	1.05	13,2	.52
32S	71,4	2.81	-32	116,6	4.59	69,9	2.75	44,5	1.75	12,7	.50

Code 61 SAE J518 30° Split Flange

198046-

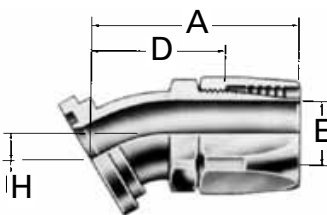

Dash Size	Flange Head Dia.		Hose Size	A		D		EØ		H	
	mm	in		mm	in	mm	in	mm	in	mm	in
198046-											
16-12S	44,5	1.75	-12	91,4	3.60	51,6	2.03	14,0	.55	11,4	.45
16S	44,5	1.75	-16	84,3	3.32	52,1	2.05	20,8	.82	12,7	.50
20-16S	50,8	2.00	-16	84,3	3.32	52,1	2.05	20,8	.82	12,7	.50
20S	50,8	2.00	-20	92,2	3.63	57,4	2.26	26,7	1.05	13,2	.52
24S	60,5	2.38	-24	100,6	3.96	63,8	2.51	32,5	1.28	14,7	.58
32S	71,4	2.81	-32	118,9	4.68	72,1	2.84	44,5	1.75	16,5	.65

* Order as 39-4775-40.

NOTE: For flanges, split flange halves, kits and o-rings see pages 190-194.

NOTE: For correct socket part number, see page 65.

Reusable Fittings

100R5 Style

For use with Hose:

302A, 303, 1503, 2580, 2651,
FC234, FC300, FC321, FC350,
FC355

Code 61 SAE J518 45° Split Flange

4777-

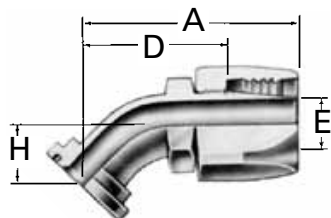

Dash Size	Flange Head Dia.		Hose Size	A		D		EØ		H	
	mm	in		mm	in	mm	in	mm	in	mm	in
4777-											
8S	30,2	1.19	-08	87,4	3.44	58,4	2.30	9,1	.36	25,4	1.00
12S	38,1	1.50	-12	102,1	4.02	62,2	2.45	14,0	.55	25,4	1.00
16-12S	44,5	1.75	-12	102,1	4.02	62,2	2.45	14,0	.55	25,4	1.00
20-12S	50,8	2.00	-12	102,1	4.02	62,2	2.45	14,0	.55	25,4	1.00
16S	44,5	1.75	-16	96,5	3.80	64,3	2.53	20,8	.82	28,4	1.12
16-20S	44,5	1.75	-20	101,9	4.01	67,3	2.65	20,8	.82	28,4	1.12
20-16S	50,8	2.00	-16	96,5	3.80	64,3	2.53	20,8	.82	28,4	1.12
20S	50,8	2.00	-20	104,6	4.12	69,9	2.75	26,7	1.05	28,4	1.12
24-20S	60,5	2.38	-20	104,6	4.12	69,9	2.75	26,7	1.05	28,4	1.12
32-20S	46,0	1.81	-20	105,7	4.16	71,1	2.80	26,7	1.05	29,7	1.17
24S	60,5	2.38	-24	111,3	4.38	74,2	2.92	32,5	1.28	28,4	1.12
24-32S	60,5	2.38	-32	121,4	4.78	74,7	2.94	34,8	1.37	28,4	1.12
32-24S	71,4	2.81	-24	111,3	4.38	74,2	2.92	32,5	1.28	28,4	1.12
32S	71,4	2.81	-32	131,6	5.18	84,6	3.33	44,5	1.75	31,8	1.25
40-32S	84,1	3.31	-32	132,6	5.22	85,9	3.38	44,5	1.75	33,0	1.30
40*	84,1	3.31	-40	167,1	6.58	118,6	4.67	56,1	2.21	42,1	1.66

Code 61 SAE J518 60° Split Flange

191395-

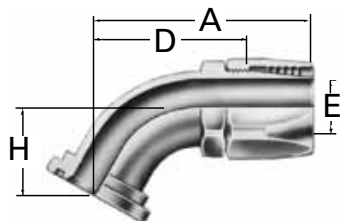

Dash Size	Flange Head Dia.		Hose Size	A		D		EØ		H	
	mm	in		mm	in	mm	in	mm	in	mm	in
191395-											
12S	38,1	1.50	-12	105,4	4.15	65,5	2.58	14,0	.55	41,1	1.62
16S	44,5	1.75	-16	98,0	3.86	66,0	2.60	20,8	.82	41,7	1.64
20S	50,8	2.00	-20	107,2	4.22	72,6	2.86	26,7	1.05	41,7	1.64
24S	60,5	2.38	-24	120,1	4.73	83,3	3.28	32,5	1.28	50,8	2.00

Code 61 SAE J518 90° Split Flange

4779-

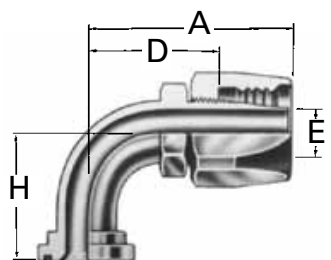

Dash Size	Flange Head Dia.		Hose Size	A		D		EØ		H	
	mm	in		mm	in	mm	in	mm	in	mm	in
4779-											
8S	30,2	1.19	-08	73,2	2.88	43,9	1.73	9,1	.36	41,1	1.62
12S	38,1	1.50	-12	95,0	3.74	55,1	2.17	14,0	.55	53,8	2.12
16-12S	44,5	1.75	-12	95,0	3.74	55,1	2.17	14,0	.55	53,8	2.12
12-16S	38,1	1.50	-16	83,8	3.30	51,6	2.03	20,8	.82	53,8	2.12
16S	44,5	1.75	-16	90,2	3.55	57,9	2.28	20,8	.82	60,5	2.38
20-16S	50,8	2.00	-16	90,2	3.55	57,9	2.28	20,8	.82	60,5	2.38
16-20S	44,5	1.75	-20	95,5	3.76	60,9	2.40	20,8	.82	60,5	2.38
20S	50,8	2.00	-20	102,1	4.02	67,3	2.65	26,7	1.05	63,5	2.50
24-20S	60,5	2.38	-20	102,1	4.02	67,3	2.65	26,7	1.05	63,5	2.50
32-20S	71,4	2.81	-20	102,1	4.02	67,3	2.65	26,7	1.05	65,0	2.56
20-24S	50,8	2.00	-24	104,4	4.11	67,6	2.66	26,7	1.05	63,5	2.50
24S	60,5	2.38	-24	112,2	4.42	75,4	2.97	32,5	1.28	69,9	2.75
24-32S	60,5	2.38	-32	122,7	4.83	75,7	2.98	34,8	1.37	69,9	2.75
32S	71,4	2.81	-32	136,9	5.39	90,2	3.55	44,5	1.75	82,6	3.25
40-32S	84,1	3.31	-32	136,9	5.39	90,2	3.55	44,5	1.75	84,1	3.31
40**	84,1	3.31	-40	184,4	7.26	136,1	5.36	56,1	2.21	131,8	5.19

NOTE: For flanges, split flange halves, kits and o-rings see pages 190-194. *Order as 39-4775-40

NOTE: For correct socket part number, see page 65. **Order as 39-4779-40

SPECIALTY &
TRUCK HOSE

LOW & MEDIUM
PRESSURE HOSE

HIGH PRESSURE HOSE

HOSE FITTINGS

ADAPTERS &
TUBE FITTINGS

ACCESSORIES &
ASSEMBLY INSTRUCTIONS

HOSE ASSEMBLY
EQUIPMENT

APPENDICES

Reusable Fittings

100R5 Style

For use with Hose:

302A, 303, 1503, 2580, 2651,
FC234, FC300, FC321, FC350,
FC355

Male Inverted Flare

190277-

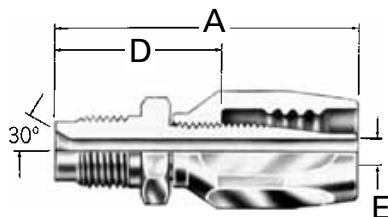

Dash Size	Thread	Hose Size	A		D		EØ	
190277-			mm	in	mm	in	mm	in
4S	7/16-20	-04	45,7	1.80	26,7	1.05	3,3	.13

Male/Female Inverted Flare

190276-

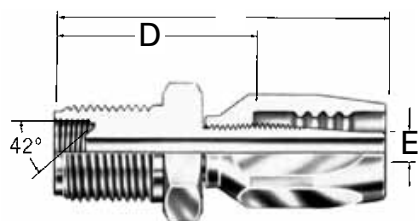

Dash Size	Thread	Hose Size	A		D		EØ	
190276-			mm	in	mm	in	mm	in
4S	5/8-18(M)	-04	52,1	2.05	33,0	1.30	3,3	.13
	7/16-24(F)							

Female Inverted Flare

403-

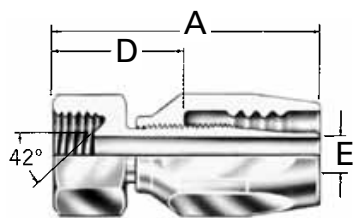

Dash Size	Thread	Hose Size	A		D		EØ	
403-			mm	in	mm	in	mm	in
5S	1/2-20	-05	41,1	1.62	21,3	.84	5,8	.23
6S	5/8-18	-06	45,2	1.78	22,4	.88	7,6	.30

Compression Ball Sleeve

FC7031-

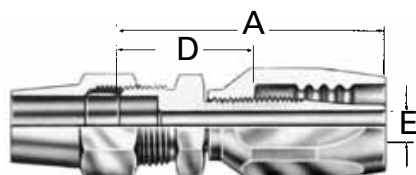

Dash Size	Thread	Hose Size	A		D		EØ	
FC7031-			mm	in	mm	in	mm	in
0808-206	1/2	-08	59,9	2.36	30,5	1.20	9,1	.36
1010-206	5/8	-10	66,5	2.62	34,0	1.34	11,7	.46

Straight SAE Male Inverted Flare

190111-

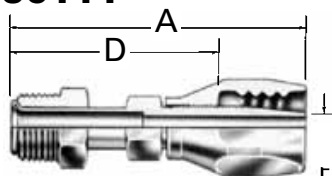

Dash Size	Thread	Hose Size	A		D		EØ	
190111-			mm	in	mm	in	mm	in
4S	7/16-24	-04	62,5	2.46	43,4	1.71	3,3	.13
5S	1/2-20	-05	66,5	2.62	46,7	1.84	4,6	.18
5-6S	1/2-20	-06	69,1	2.72	46,2	1.82	6,1	.24
6S	5/8-18	-06	69,1	2.72	46,2	1.82	6,1	.24
6-8S	5/8-18	-08	79,5	3.13	50,8	1.98	7,1	.28
8S	3/4-18	-08	81,3	3.20	52,1	2.05	9,1	.36

NOTE: For correct socket part number, see page 65.

Reusable Fittings

100R5 Style

For use with Hose:

302A, 303, 1503, 2580, 2651,
FC234, FC300, FC321, FC350,
FC355

15° Elbow SAE Male Inverted Flare

190350-

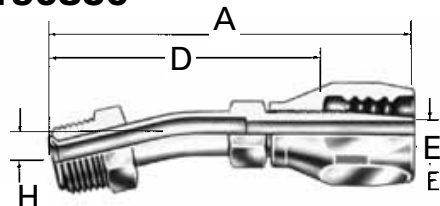

Dash Size	Thread	Hose Size	A		D		EØ		H	
			mm	in	mm	in	mm	in	mm	in
190350-										
6S	5/8-18	-06	82,8	3.26	59,9	2.36	6,1	.24	9,4	.37

45° Elbow SAE Male Inverted Flare

190371-

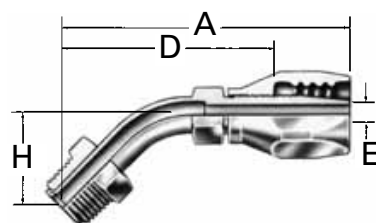

Dash Size	Thread	Hose Size	A		D		EØ		H	
			mm	in	mm	in	mm	in	mm	in
190371-										
4S	7/16-20	-04	69,6	2.74	50,5	1.99	3,3	.13	24,4	.96
5S	1/2-20	-05	73,7	2.90	53,8	2.12	4,3	.17	24,4	.96
6S	5/8-18	-06	76,2	3.00	53,3	2.10	6,1	.24	24,4	.96
8S	3/4-18	-08	86,1	3.39	56,9	2.24	9,1	.36	23,6	.93
10S	5/8-18	-10	95,0	3.74	62,0	2.44	11,7	.46	26,2	1.03

90° Elbow (Short) SAE Male Inverted Flare

190235-

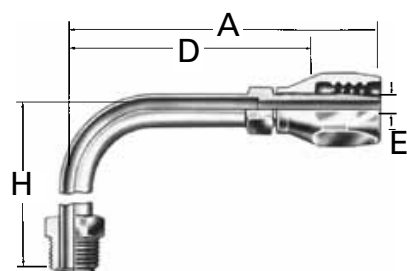

Dash Size	Thread	Hose Size	A		D		EØ		H	
			mm	in	mm	in	mm	in	mm	in
190235-										
4S	7/16-24	-04	59,9	2.36	41,1	1.62	3,3	.13	42,9	1.69
7-4S	11/16-18	-04	53,8	2.12	34,5	1.36	3,3	.13	46,7	1.84
8-4S	3/4-18	-04	53,8	2.12	34,5	1.36	3,3	.13	46,7	1.84
5S	1/2-20	-05	64,3	2.53	44,5	1.75	4,6	.18	42,9	1.69
6S	5/8-18	-06	66,8	2.63	43,9	1.73	6,1	.24	43,9	1.73
7-6S	11/16-18	-06	66,8	2.63	43,9	1.73	6,1	.24	43,9	1.73
6-8S	5/8-18	-08	77,2	3.04	48,0	1.89	7,1	.28	43,9	1.73
7-8S	11/16-18	-08	77,2	3.04	48,0	1.89	7,1	.28	43,9	1.73
8S	3/4-18	-08	77,2	3.04	48,0	1.89	9,1	.36	44,5	1.75
10S	7/8-18	-10	87,4	3.44	54,6	2.15	11,7	.46	56,4	2.22
8-12S	3/4-18	-12	88,6	3.49	48,8	1.92	9,9	.39	44,5	1.75

90° Elbow (Long) SAE Male Inverted Flare

190325-

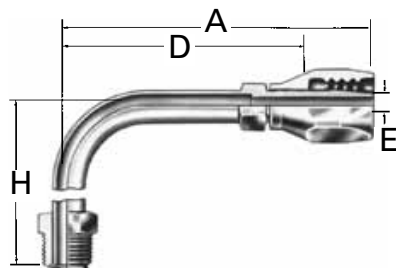

Dash Size	Thread	Hose Size	A		D		EØ		H	
			mm	in	mm	in	mm	in	mm	in
190325-										
6S	5/8-18	-06	93,2	3.67	70,4	2.77	6,1	.24	69,3	2.73

NOTE: For correct socket part number, see page 65.

SPECIALTY &
TRUCK HOSE

LOW & MEDIUM
PRESSURE HOSE

HIGH PRESSURE HOSE

HOSE FITTINGS

ADAPTERS &
TUBE FITTINGS

ACCESSORIES &
ASSEMBLY INSTRUCTIONS

HOSE ASSEMBLY
EQUIPMENT

APPENDICES

Reusable Fittings

100R5 Style

For use with Hose:

302A, 303, 1503, 2580, 2651,
FC234, FC300, FC321, FC350,
FC355

ORS Swivel Straight

FJ9706-

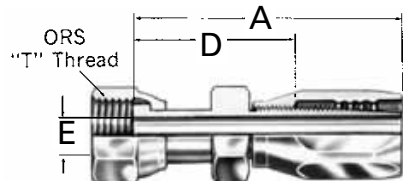

Dash Size	"T" Thread	Hose Size	A		D		EØ	
			mm	in	mm	in	mm	in
FJ9706-			mm	in	mm	in	mm	in
0404S	9/16-18	-04	53,1	2.09	34,0	1.34	3,3	.13
0405S	9/16-18	-05	51,6	2.03	31,8	1.25	4,3	.17
0606S	11/16-16	-06	61,7	2.43	38,9	1.53	6,1	.24
0808S	13/16-16	-08	79,5	3.13	50,8	1.98	9,1	.36
1010S	1-14	-10	85,6	3.37	52,8	2.08	11,7	.46
1212S	13/16-12	-12	93,5	3.68	53,6	2.11	14,0	.55
1616S	17/16-12	-16	88,9	3.50	56,6	2.23	20,8	.82
2020S	111/16-12	-20	92,5	3.64	57,9	2.28	26,7	1.05
2424S	2-12	-24	98,0	3.86	60,9	2.40	32,0	1.26

ORS Swivel 45° Elbow

FJ9707-

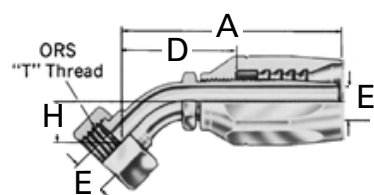

Dash Size	"T" Thread	Hose Size	A		D		EØ		H	
			mm	in	mm	in	mm	in	mm	in
FJ9707-			mm	in	mm	in	mm	in	mm	in
0404S	9/16-18	-04	49,8	1.96	30,7	1.21	3,3	.13	10,4	.41
0606S	11/16-16	-06	57,7	2.27	34,8	1.37	5,6	.22	10,9	.43
0806S	13/16-16	-06	68,1	2.68	45,2	1.78	6,1	.24	15,0	.59
0808S	13/16-16	-08	77,0	3.03	47,8	1.88	9,1	.36	15,0	.59
1010S	1-14	-10	85,9	3.38	52,8	2.08	11,7	.46	16,5	.65
1212S	13/16-12	-12	97,5	3.84	57,7	2.27	14,0	.55	21,1	.83
1616S	17/16-12	-16	91,9	3.62	59,7	2.35	19,3	.76	23,9	.94
2020S	111/16-12	-20	103,9	4.09	69,1	2.72	25,7	1.01	25,4	1.00
2424S	2-12	-24	109,7	4.32	72,9	2.87	32,0	1.26	27,2	1.07

ORS Swivel 90° Elbow (Short drop)

FJ9708-

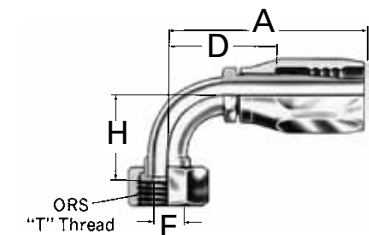

Dash Size	"T" Thread	Hose Size	A		D		EØ		H	
			mm	in	mm	in	mm	in	mm	in
FJ9708-			mm	in	mm	in	mm	in	mm	in
0404S	9/16-18	-04	45,7	1.80	26,7	1.05	3,3	.13	20,8	.82
0606S	11/16-16	-06	54,1	2.13	31,2	1.23	5,6	.22	22,9	.90
0808S	13/16-16	-08	70,1	2.76	40,9	1.61	9,1	.36	29,2	1.15
1010S	1-14	-10	77,0	3.03	44,2	1.74	11,7	.46	32,3	1.27
1212S	13/16-12	-12	95,0	3.74	55,1	2.17	14,0	.55	47,8	1.88
1616S	7/16-12	-16	90,2	3.55	57,9	2.28	19,3	.76	56,1	2.21
2020S	111/16-12	-20	102,1	4.02	67,3	2.65	25,7	1.01	63,8	2.51
2424S	2-12	-24	112,2	4.42	75,4	2.97	32,0	1.26	68,6	2.70

ORS Swivel 90° Elbow (Long drop)

FJ9709-

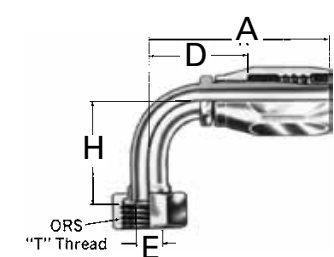

Dash Size	"T" Thread	Hose Size	A		D		EØ		H	
			mm	in	mm	in	mm	in	mm	in
FJ9709-			mm	in	mm	in	mm	in	mm	in
0404S	9/16-18	-04	45,7	1.80	26,7	1.05	3,3	.13	45,7	1.80
0606S	11/16-16	-06	57,2	2.25	34,3	1.35	5,6	.22	54,1	2.13
0808S	13/16-16	-08	73,2	2.88	43,9	1.73	9,1	.36	63,8	2.51
1010S	1-14	-10	77,0	3.03	44,2	1.74	11,7	.46	70,1	2.76
1212S	13/16-12	-12	95,0	3.74	55,1	2.17	14,0	.55	96,0	3.78
1616S	7/16-12	-16	90,2	3.55	57,7	2.27	19,3	.76	114,3	4.50
2020S	111/16-12	-20	102,1	4.02	67,3	2.65	25,7	1.01	129,3	5.09
2424S	2-12	-24	112,2	4.42	75,4	2.97	32,0	1.26	140,7	5.54

NOTE: For correct socket part number, see page 65.

Reusable Fittings

100R5 Style

For use with Hose:

302A, 303, 1503, 2580, 2651,
FC234, FC300, FC321, FC350,
FC355

BSP Male

07.340-

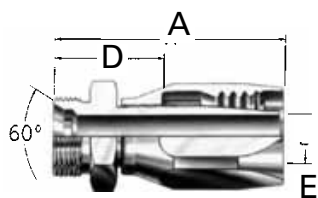

Dash Size	"T" Thread	Hose Size	A		D		EØ	
			mm	in	mm	in	mm	in
07.340-								
4-4	1/4-19	-04	46,5	1.83	27,5	1.08	3,2	.13
6-6	3/8-19	-06	53,0	2.09	30,0	1.18	6,0	.24
8-8	1/2-14	-08	64,0	2.52	34,5	1.35	9,0	.35
10-10	5/8-14	-10	71,0	2.80	38,0	1.50	11,5	.45
12-12	3/4-14	-12	79,5	3.13	39,5	1.56	14,0	.55
16-16	1-11	-16	71,5	2.81	39,0	1.54	21,0	.83
20-20	1 1/4-11	-20	74,0	2.91	39,5	1.56	26,5	1.04
24-24	1 1/2-11	-24	77,5	3.05	40,5	1.59	32,5	1.28
32-32	2-11	-32	95,5	3.76	48,5	1.91	44,5	1.75

BSP Female Swivel

07.421-

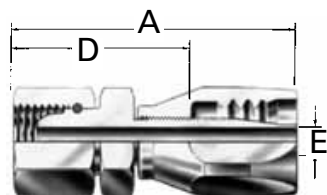

Dash Size	Thread	Hose Size	A		D		EØ	
			mm	in	mm	in	mm	in
07.421-								
4-4	1/4-19	-04	52,0	2.05	33,0	1.30	3,0	.13
6-6	3/8-19	-06	59,5	2.34	36,5	1.44	6,0	.24
8-6	1/2-19	-06	61,0	2.40	38,0	1.50	6,0	.24
8-8	1/2-14	-08	70,0	2.76	40,5	1.59	9,0	.35
10-10	5/8-14	-10	75,5	2.97	43,0	1.69	11,5	.45
12-10	3/4-14	-10	77,0	3.03	44,0	1.73	11,5	.45
12-12	3/4-14	-12	84,5	3.33	44,5	1.75	14,0	.55
16-16	1-11	-16	78,0	3.07	45,5	1.79	21,0	.83
20-20	1 1/4-11	-20	81,5	3.21	47,0	1.85	26,5	1.04
24-24	1 1/2-11	-24	87,0	3.43	50,0	1.97	32,5	1.28
32-32	2-11	-32	101,0	3.98	54,0	2.13	44,5	1.75

*RØ dimension is tube O.D. and refers to mating component when not called out on the illustration.

NOTE: For correct socket part number, see page 65.

SPECIALTY &
TRUCK HOSE

LOW & MEDIUM
PRESSURE HOSE

HIGH PRESSURE HOSE

HOSE FITTINGS

ADAPTERS &
TUBE FITTINGS

ACCESSORIES &
ASSEMBLY INSTRUCTIONS

HOSE ASSEMBLY
EQUIPMENT

APPENDICES

Reusable Fittings

100R5 Style

For use with Hose:

302A, 303, 1503, 2580, 2651,
FC234, FC300, FC321, FC350,
FC355

Metric Male 60° DIN 7631/7647

07.024-

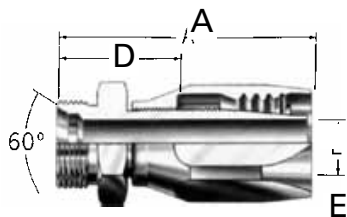

Dash Size	Thread	Hose Size	A		D		EØ	
			mm	in	mm	in	mm	in
07.024-			mm	in	mm	in	mm	in
4-4	M12 x 1.5	-04	45,0	1.77	26,0	1.02	3,2	.13
6-5	M14 x 1.5	-05	47,5	1.87	27,5	1.08	4,5	.18
8-6	M16 x 1.5	-06	50,0	1.97	27,0	1.06	6,0	.24
10-8	M18 x 1.5	-08	59,0	2.32	30,0	1.18	9,0	.35
13-10	M22 x 1.5	-10	65,0	2.56	32,0	1.26	11,5	.45
16-12	M26 x 1.5	-12	72,5	2.85	32,5	1.28	14,0	.55
20-16	M30 x 1.5	-16	63,0	2.48	31,0	1.22	21,0	.83
25-20	M38 x 1.5	-20	67,5	2.66	33,0	1.30	26,5	1.04
32-24	M45 x 1.5	-24	70,0	2.76	33,0	1.30	32,5	1.28
40-32	M52 x 1.5	-32	84,0	3.31	37,0	1.46	44,5	1.28
50-32	M65 x 2	-32	87,0	3.42	40,0	1.57	44,5	1.75
60-40	M78 x 2	-40	94,5	3.72	46,0	1.81	56,0	2.20
70-48	M90 x 2	-48	100,5	3.96	52,0	2.05	71,0	2.80

Metric Male 24° DIN 3901/3902 I.Rh.

07.003-

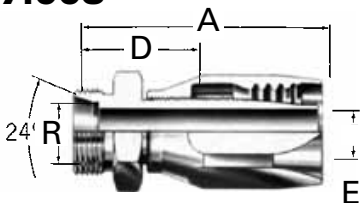

Dash Size	Thread	Hose Size	A		D		EØ		RØ	
			mm	in	mm	in	mm	in	mm	in
07.003-			mm	in	mm	in	mm	in	mm	in
6-4	M12 x 1.5	-04	45,0	1.77	26,0	1.02	3,2	.13	6,0	.24
8-5	M14 x 1.5	-05	47,5	1.87	27,5	1.08	4,5	.18	8,0	.31
10-6	M16 x 1.5	-06	51,0	2.01	28,0	1.10	6,0	.24	10,0	.39
12-6	M18 x 1.5	-06	51,0	2.01	28,0	1.10	6,0	.24	12,0	.47
12-8	M18 x 1.5	-08	60,0	2.36	30,5	1.20	9,0	.35	12,0	.47
15-10	M22 x 1.5	-10	65,0	2.56	32,0	1.26	11,5	.45	15,0	.59
18-10	M26 x 1.5	-10	65,0	2.56	32,0	1.26	11,5	.45	18,0	.71
18-12	M26 x 1.5	-12	72,5	2.85	32,5	1.28	14,0	.55	18,0	.71
22-16	M30 x 2	-16	65,0	2.56	32,5	1.28	21,0	.83	22,0	.87
28-20	M36 x 2	-20	67,5	2.66	33,0	1.30	26,5	1.04	28,0	1.10
35-24	M45 x 2	-24	72,0	2.83	35,0	1.38	32,5	1.28	35,0	1.38
42-32	M52 x 2	-32	86,0	3.38	39,0	1.54	44,5	1.75	42,0	1.65

Metric Male 24° DIN 3901/3902 s.Rh.

07.026-

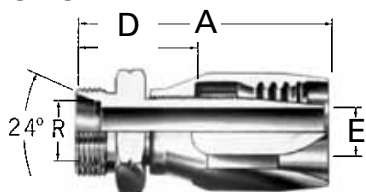

Dash Size	Thread	Hose Size	A		D		EØ		RØ	
			mm	in	mm	in	mm	in	mm	in
07.026-			mm	in	mm	in	mm	in	mm	in
8-4	M16 x 1.5	-04	47,0	1.85	28,0	1.10	3,2	.13	8,0	.31
10-5	M18 x 1.5	-05	49,5	1.95	29,5	1.16	4,5	.18	10,0	.39
12-6	M20 x 1.5	-06	52,0	2.05	29,0	1.14	6,0	.24	12,0	.47
14-8	M22 x 1.5	-08	63,0	2.48	33,5	1.32	9,0	.35	14,0	.55
16-10	M24 x 1.5	-10	67,0	2.64	34,0	1.34	11,5	.45	16,0	.63
20-12	M30 x 2	-12	78,5	3.09	38,5	1.52	14,0	.55	20,0	.79
25-16	M36 x 2	-16	69,0	2.72	36,5	1.44	21,0	.83	25,0	.98
30-20	M42 x 2	-20	73,5	2.89	39,0	1.54	26,5	1.04	30,0	1.18
38-24	M52 x 2	-24	80,0	3.15	43,0	1.69	32,5	1.28	38,0	1.50

*RØ dimension is tube O.D. and refers to mating component when not called out on the illustration.

NOTE: For correct socket part number, see page 65.

Reusable Fittings

100R5 Style

For use with Hose:

302A, 303, 1503, 2580, 2651,
FC234, FC300, FC321, FC350,
FC355

Metric Female Swivel 60° DIN 7631/7647 07.036-

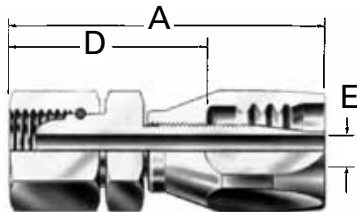

Dash Size	Thread	Hose Size	A		D		EØ	
			mm	in	mm	in	mm	in
07.036-			mm	in	mm	in	mm	in
20-16	M30 x 1.5	-16	72,5	2.85	40,9	1.61	21,0	.83
25-20	M38 x 1.5	-20	76,5	3.01	42,0	1.65	26,5	1.04
32-24	M45 x 1.5	-24	82,0	3.23	45,0	1.77	32,5	1.28
40-32	M52 x 1.5	-32	93,5	3.68	46,5	1.83	44,5	1.75
50-32	M65 x 2	-32	93,5	3.68	46,5	1.83	44,5	1.75
60-40	M78 x 2	-40	103,0	4.06	54,5	2.15	56,0	2.20
70-48	M90 x 2	-48	108,5	4.27	60,0	2.36	71,0	2.80

Metric Universal Female Swivel 24° DIN 3901/3902 I.Rh. 07.002-

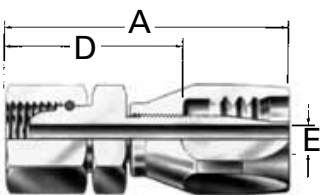

Dash Size	Thread	Hose Size	A		D		EØ		RØ	
			mm	in	mm	in	mm	in	mm	in
07.002-			mm	in	mm	in	mm	in	mm	in
4-4†	M12 x 1.5	-04	51,0	2.01	32,0	1.26	3,2	.13	6,0	.24
6-5†	M14 x 1.5	-05	53,5	2.11	33,5	1.32	4,5	.18	8,0	.31
8-6†	M16 x 1.5	-06	56,5	2.22	33,5	1.32	6,0	.24	10,0	.39
10-8†	M18 x 1.5	-08	67,0	2.64	37,5	1.48	9,0	.35	12,0	.47
13-10†	M22 x 1.5	-10	73,0	2.87	40,5	1.59	11,5	.45	15,0	.59
16-12†	M26 x 1.5	-12	83,5	3.29	43,5	1.71	14,0	.55	18,0	.71
22-16	M30 x x 2	-16	74,0	2.91	41,5	1.63	21,0	.83	22,0	.87
28-20	M36 x x 2	-20	78,0	3.07	43,5	1.71	26,5	1.04	28,0	1.10
35-24	M45 x x 2	-24	81,5	3.21	44,5	1.75	32,5	1.28	35,0	1.38
42-32	M52 x x 2	-32	94,0	3.70	47,0	1.85	44,5	1.75	42,0	1.65

Metric Universal Female Swivel 24° DIN 3901/3902 s.Rh. 07.155-

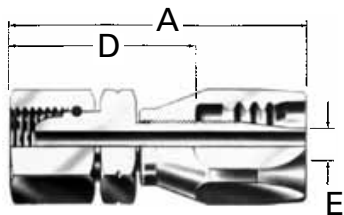

Dash Size	Thread	Hose Size	A		D		EØ		RØ	
			mm	in	mm	in	mm	in	mm	in
07.155-			mm	in	mm	in	mm	in	mm	in
8-4	M16 x 1.5	-04	52,5	2.07	33,5	1.32	3,2	.13	08,0	.31
10-5	M18 x 1.5	-05	55,0	2.17	35,0	1.38	4,5	.18	10,0	.39
12-6	M20 x 1.5	-06	59,5	2.34	36,5	1.44	6,0	.24	12,0	.47
14-8	M22 x 1.5	-08	68,5	2.70	39,0	1.54	9,0	.35	14,0	.55
16-10	M24 x 1.5	-10	74,5	2.93	41,5	1.63	11,5	.45	16,0	.63
20-12	M30 x 2	-12	85,5	3.37	45,5	1.79	14,0	.55	20,0	.79
25-16	M36 x 2	-16	75,0	2.95	42,5	1.67	21,0	.83	25,0	.98
30-20	M42 x 2	-20	78,5	3.09	44,0	1.73	26,5	1.04	30,0	1.18
38-24	M52 x 2	-24	84,0	3.31	47,0	1.85	32,5	1.28	38,0	1.50

Komatsu 30° Metric Female Swivel FC5954-

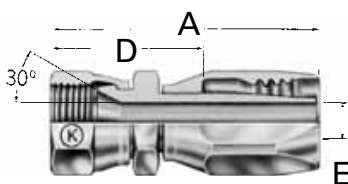

Dash Size	Thread	Hose Size	A		D		EØ	
			mm	in	mm	in	mm	in
FC5954-			mm	in	mm	in	mm	in
0306S	M18 x 1.5	-06	63,3	2.49	40,4	1.59	6,1	.24
0410S	M22 x 1.5	-10	78,7	3.10	46,2	1.82	9,4	.37
0512S	M24 x 1.5	-12	90,2	3.55	50,3	1.98	12,2	.48
0612S	M30 x 1.5	-12	95,5	3.76	55,6	2.19	14,0	.55
1016S	M33 x 1.5	-16	90,2	3.55	57,9	2.28	20,8	.82
1424S	M42 x 1.5	-24	107,7	4.12	67,8	2.67	30,2	1.19

*RØ dimension is tube O.D. and refers to mating component when not called out on the illustration.

NOTE: For correct socket part number, see page 65.

† Universal fitting also mates with DIN 7631/7647 60° connections.

SPECIALTY &
TRUCK HOSE

LOW & MEDIUM
PRESSURE HOSE

HIGH PRESSURE HOSE

HOSE FITTINGS

ADAPTERS &
TUBE FITTINGS

ACCESSORIES &
ASSEMBLY INSTRUCTIONS

HOSE ASSEMBLY
EQUIPMENT

APPENDICES